

MRI ***with the*** ***VNS Therapy® System***



October 2019

RxOnly

CE 0344

The year of authorization to affix the CE mark:

102/102R - 2003
103/104 - 2005
105 - 2011
106 - 2014
1000 - 2017
8103 - 2019
302 - 2003
303 - 2006
304 - 2009

The information contained in this document is one part of the full labeling for the implanted portions of the VNS Therapy System. It is not intended to serve as a substitute for a complete and thorough understanding of the material presented in all VNS Therapy physician manuals, nor does this represent full disclosure of all pertinent information concerning use of this product, potential safety complications, or efficacy outcomes.

MRI WARNING AND PRECAUTIONS

The following warning and precautions are taken directly from the *Introduction to VNS Therapy* chapter in the *VNS Therapy System Physician's Manual*:

WARNING

-  **Magnetic resonance imaging (MRI)** — Patients with the VNS Therapy System, or any part of the VNS Therapy System, implanted should have MRI procedures performed **only as described in the MRI with the VNS Therapy System instructions for use**. In some cases, surgery will be required to remove the VNS Therapy System if a scan using a transmit RF body coil is needed.

PRECAUTIONS



-  **Magnetic resonance imaging (MRI)** — An MRI should not be performed using a transmit RF body coil for certain VNS Therapy device configurations or under certain specific conditions. In some cases, heating of the lead caused by the transmit RF body coil during MRI may result in serious injury. Static, gradient, and radio frequency (RF) electromagnetic fields associated with MRI may change the generator settings (i.e., reset parameters) or activate the VNS device if the Magnet Mode output remains “ON”.
-  **Receive RF coils** — Note that certain magnetic resonance (MR) system head coils operate in receive-only mode and require use of the transmit RF body coil. Other MR systems use a transmit/receive RF head coil. Local or surface coils may also be receive-only RF coils that require the transmit RF body coil for MRI. **The use of a receive RF coil does not alter hazards of the transmit RF body coil.**
-  **Transmit RF coils** — Exposure of the VNS Therapy System to any transmit RF coil must be avoided. Do not perform MRI scans using any transmit RF coil in the defined exclusion zones.

TABLE OF CONTENTS

1	INTRODUCTION	4
1.1	MR Conditional Device	4
1.2	MRI Guidance Applicability	5
2	MRI GUIDELINES	6
2.1	Pre-MRI Considerations and Preparation	6
2.2	Conditional MR Environments for VNS	7
2.2.1.	Precautions	7
2.2.2.	MRI Conditions for Use	8
2.2.3.	Acceptable MR Imaging Scenarios (1.5 and 3.0 T)	9
2.2.3.1.	<i>Brain scan configurations</i>	9
2.2.3.2.	<i>Extremity scan configurations</i>	9
2.2.4.	Unsafe MR Conditions	11
2.2.5.	Unsafe MR Imaging Scenarios	11
2.2.6.	Special Cases and Considerations	12
2.2.6.1.	<i>Partially explanted VNS Therapy Systems or damaged leads</i>	12
2.2.6.2.	<i>Assessing Lead Segment Length</i>	13
2.2.7.	MR Unsafe Devices	14
2.3	Post-MRI Assessment	15
3	POTENTIAL RISKS AND EFFECTS OF MRI WITH VNS	15
3.1	MRI-related Heating Effects	16
3.2	Gradient Induced Current	16
3.3	Device Reset (Model 8103, Model 104 and Earlier Devices)	17
3.4	VNS Magnet Mode Activation	17
3.5	VNS AutoStim Mode - Model 106 and 1000 Only	17
3.6	Vibration or Movement	18
3.7	Image Artifacts and Distortions	18
3.8	Device Malfunction or Damage	18

LIST OF TABLES

Table 1	Device Settings	6
Table 2	Summary of Conditional MR Use	8
Table 3	Scan Conditions for Partially Explanted VNS Therapy Systems or Damaged Leads	13
Table 1	Image Artifacts and Distortions	18

LIST OF FIGURES

Figure 1	Head MR Imaging	9
Figure 2	MR Imaging for Extremities	10
Figure 3	Unsafe MR - Exclusion Zone	11
Figure 4	Unsafe MR Imaging	12
Figure 5	Transected Lead (≤ 2 cm)	14
Figure 6	Transected Lead (> 2 cm)	14
Figure 7	MR Unsafe Devices	15

1 INTRODUCTION

 **Note:** For a definition of VNS and MRI terms, see the *Glossary*, which can be found at www.livanova.com.

 **MR Unsafe** devices include the programming wand, computer, and patient magnet. These devices must not be brought into the MR scanner room.

1.1 MR Conditional Device

The implanted VNS Therapy System is an **MR Conditional**  device that has demonstrated safety in the MR environment within defined conditions. See “Conditional MR Environments for VNS” for specific conditions for use.

Conditions that define an MRI environment include:

- Transmit RF coil used
- Field strength of the static magnetic field (Tesla)
- Spatial gradient of the static magnetic field (Gauss/cm)
- Gradient slew rate (T/m/s)
- Radio frequency (RF) fields
- Specific absorption rate (SAR)
- Exposure time
- Scanner type (e.g., horizontal field, cylindrical closed bore)
- RF Transmission (e.g, RF shimming)
- Mode of operation (e.g., normal operating mode)

Many tests have been conducted with different VNS Therapy System device configurations. These include:

- *In vitro* tests in a variety of MRI facilities.
- Numerical simulations of multiple patient sizes and devices in numerous clinically relevant scenarios and configurations.

 **Note:** Specific programmable configurations of the VNS Therapy System device are also required *before an MRI is performed*. For details, see “Pre-MRI Considerations and Preparation”.

The results have shown that VNS Therapy System patients may be safely exposed to certain MR environments if the guidelines described herein are followed. However, there is a risk of injury if the guidelines described herein are not followed. In particular, there is a risk of injury due to heating of the lead electrodes. Adverse effects from lead electrode heating may include pain, temporary injury, necrosis, or permanent tissue damage. In the case of a broken lead, the exposed lead wire is the point at which these injuries may take place. For additional information, see “Potential Risks and Effects of MRI with VNS”.

 **Caution:** The VNS Therapy System lead can focus strong RF energy fields, such as those used during MRI, and cause excessive heating and possible injury if used outside of instructions provided herein.

1.2 MRI Guidance Applicability

MRI guidance is specific to unique VNS Therapy device configurations. Applicable devices include Models 100C, 101, 102, 102R, 103, 104, 105, 106, 1000, and 8103 generators, and Models 300, 302, 303 and 304 leads. To determine applicable group (A or B) by device configuration, follow the flowchart in Figure .

Note: For the most current MR information for VNS Therapy, contact Technical Support listed in *Information and Support*.

MRI Guidance Applicability Flowchart

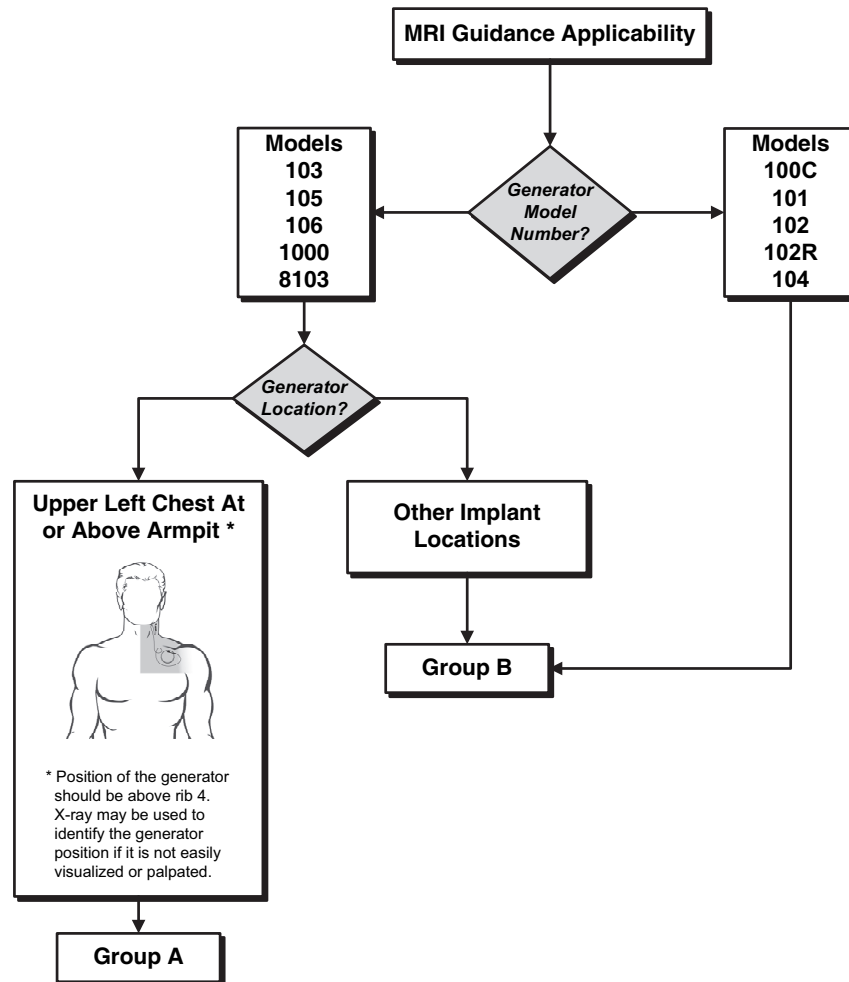

2 MRI GUIDELINES

2.1 Pre-MRI Considerations and Preparation



Caution: All VNS patients *must have their VNS Therapy System assessed and programmed* before an MRI procedure.

Patients should consult with the treating physician prior to MR imaging. The MRI should be performed at least 2 weeks after implantation or revision surgery of the VNS Therapy System. Safety has not been demonstrated in patients with the VNS Therapy System in combination with other implanted devices. Until safety has been demonstrated for patients implanted with the VNS Therapy System and another implanted device, MRI should not be performed.

Because of the need to perform diagnostics and change programming parameters, an appropriate healthcare professional with access to a VNS Therapy programming system must prepare the VNS device *before the patient enters an MR system room*.

To prepare the VNS device:

1. For Model 100-102R generators, perform an interrogation and record the following information in the patient record or on a copy of Table 1 below. This information is used to restore the device settings after the MRI scan in the rare case of a reset.

Table 1. Device Settings

Patient ID	
Model ID	
Device Serial Number	
Implantation Date	
Normal Output Current (mA)	
Signal Frequency (Hz)	
Pulse Width (µsec)	
Signal On Time (sec)	
Signal Off Time (min)	
Magnet Output Current (mA)	
Magnet On Time (sec)	
Magnet Pulse Width (µsec)	

2. For all generator models, perform System Diagnostics to ensure proper operation of the device.
3. Program the parameter settings as follows:
 - Normal Output Current: 0 mA
 - Magnet Current: 0 mA
 - Model 106 and 1000 only
 - ◆ Detection “OFF”
 - ◆ AutoStim Output Current: 0 mA

4. Turn off any other optional device features (Model 1000 only).
5. Perform an interrogation to verify that programming was successful.
6. Verify that placement of the VNS Therapy System is located between C7-T8.



Caution: MRI scans of a patient with a VNS Therapy System implanted outside C7-T8 has not been evaluated in pre-clinical testing; therefore further evaluation by the MR System operator to verify that the device will not be exposed to the RF Field is required.



Note: Magnet Mode and AutoStim Mode are not available for Model 8103.

The device has been evaluated for MRI induced risks, including heating, unintended stimulation, force, torque, device malfunction and device vibration and has been determined to be safe under the conditions specified in labeling; however, the patient may feel sensations of warmth or vibration at the implant site during the MRI scan.

2.2 Conditional MR Environments for VNS

Non-clinical testing has demonstrated the VNS Therapy System is MR Conditional . See sections below for MRI guidance for Group A and Group B devices.

2.2.1 Precautions

Group A Devices:

- If the patient requires a MRI scan of the C7-T8 area using a head/extremity coil or C7-L3 area using a body coil, surgical removal of the VNS Therapy System *will be required*.



Note: See the *Revision / Replacement / Removal* chapter for instructions.

Group B Devices:

- Do not use the transmit RF body coil for 1.5T or 3T imaging. Surgical removal of the VNS Therapy System *will be required* if MRI using a transmit RF body coil is needed.
- Not all head RF coils are transmit and receive type. Many are receive only. The use of any local receive coil with the body coil in RF transmit mode presents the same RF heating hazards as the body coil alone with no local coils.
- Exposure of the VNS Therapy System to any transmit RF coil must be avoided. Surgical removal of the VNS Therapy System *will be required* if an MRI of the C7-T8 exclusion zone is needed.

2.2.2 MRI Conditions for Use

 **Note:** These guidelines pertain to full VNS Therapy Systems (generator and lead implanted). For guidance on performing scans on patients with abandoned leads or lead segments see “Special Cases and Considerations”

The recommendations are herein based on phantom¹ tests and numerous numerical simulations of clinically relevant scenarios and implant configurations of standard 43-cm bipolar VNS leads. The results show that the VNS Therapy System can be scanned safely under the conditions listed in Table 2 with the patient in supine or prone positions.

Table 2. Summary of Conditional MR Use

VNS Device		Group A	Group B
Scanner Type		Horizontal field, cylindrical closed-bore, clinical system for hydrogen proton imaging	
Scanner Characteristics	Static magnetic field strength	1.5 or 3 T	
	Spatial field gradient	Models 100C and 101: ≤ 720 Gauss/cm Models 102 through 1000 and 8103: ≤ 3000 Gauss/cm	
	Maximum slew rate	200 T/m/s	
Scanner Operation	Operating mode	Normal Operating Mode	
	Transmit RF coil	Head or extremity coils: Scan (placement of entire coil) must be outside of C7 - T8 Body coil: Iso-center of scan (center of the MRI bore) must be outside of C7 - L3. This may be accomplished by landmarking above C7 or below L3.	Transmit/receive head or extremity coils only: Scan (placement of entire coil) must be outside of C7 - T8
	Maximum Specific Absorption Rate (SAR)	Transmit head coil: 3.2 W/kg Transmit body coil: 2.0 W/kg	Transmit/receive head coil: 3.2 W/kg
	Exposure time	Transmit head or extremity coil: No restriction Transmit body coil: ≤ 15 minutes of active scan time within a 30 minute window	Transmit/receive head or extremity coil: No restriction
	Additional Restriction(s)	Transmit head or extremity coil: None Transmit body coil: Circularly Polarized (CP) mode only (i.e., no shimming)	none

Specific absorption rate (SAR) is a measure of RF power deposition in the patient, usually expressed in watts per kilogram (W/kg). For a given MR system, higher SAR leads to greater heating. For imaging VNS patients, SAR values are maximum head-averaged when using the transmit/receive head coil and whole body averaged as reported by the MRI equipment when using the body coil.



Caution: (Group B devices only) Not all head RF coils are transmit and receive type. Many are receive only. The use of any extremity receive coil with the body coil in RF transmit mode presents the same RF heating hazards as the body coil alone with no extremity coils.



Caution: Exposure of the VNS Therapy System to any transmit RF coil must be avoided.

¹ Phantom—A patient-equivalent form filled with gelled saline, used for *in vitro* tests of MRI-related heating.

2.2.3 Acceptable MR Imaging Scenarios (1.5 and 3.0 T)

2.2.3.1 Brain scan configurations

Figure 1 demonstrates acceptable configurations for a brain scan. The shaded regions in the figure represent the field of view of the imaging coil.

Group A and Group B Devices:

The transmit/receive head coil is placed outside of the C7-T8 exclusion zone, which results in minimal or no exposure of VNS to RF energy. See Figure 1-1.

Group A Devices:

The brain may also be scanned using the transmit RF body coil. In this case, the iso-center (center of the MRI bore) must be above C7. This may be accomplished by landmarking above C7. With this configuration, either the body coil or head coil may be used as the receive coil. See Figure 1-2.

Figure 1. Head MR Imaging

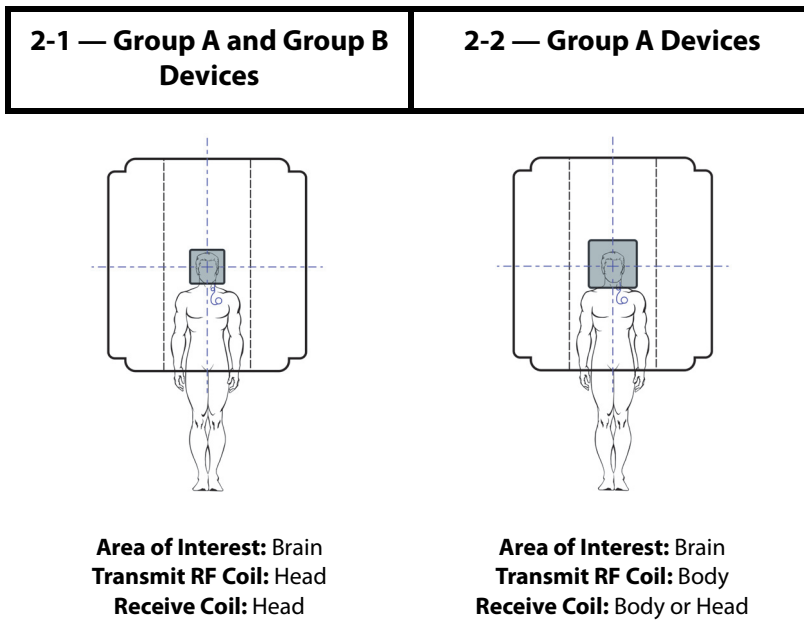

Note: The crosshairs indicate the iso-center of the MR system's bore (i.e., landmark placement).

2.2.3.2 Extremity scan configurations

Caution: Do not perform scans using any transmit RF coil in the defined exclusion zones.

Figure 2 demonstrates acceptable configurations for extremity scans such as knee, ankle or wrist. The shaded regions in the figure represent the field of view of the head, extremity or body coil.

Group A and Group B Devices:

The appropriate transmit/receive extremity coil is used outside of the C7-T8 exclusion zone, which results in minimal or no exposure of VNS to RF energy. See Figure 2-1.

Group A Devices:

The same areas of interest may be scanned using the transmit RF body coil. In these cases, the iso-center (center of the MRI bore) must be outside of the C7-L3 exclusion zone. This may be accomplished by landmarking above C7 or below L3. In these configurations, either the body coil or extremity coil may be used as the receive coil. See Figure 2-2.

Figure 2. MR Imaging for Extremities

3-1 — Group A and Group B Devices

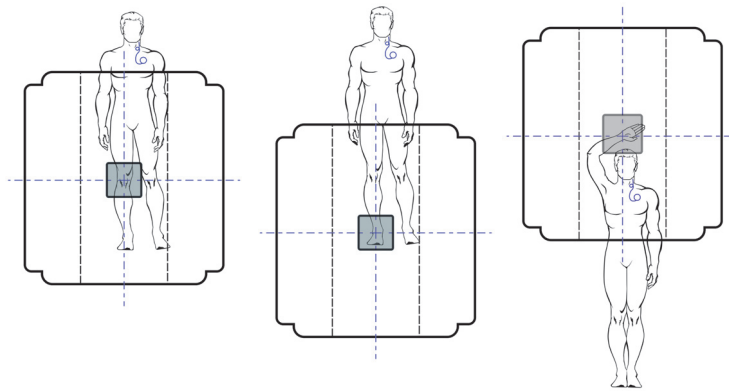

Area of Interest: Knee, Ankle, Wrist
Transmit RF Coil: Extremity
Receive Coil: Extremity

3-2 — Group A Devices

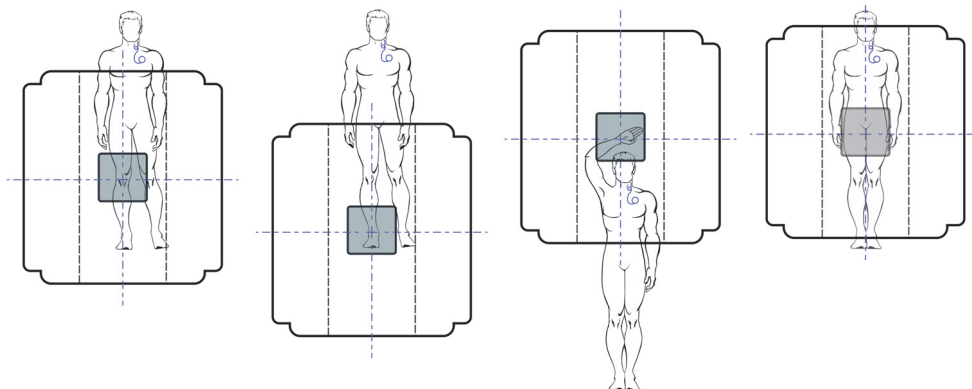

Area of Interest: Knee, Ankle, Wrist, Lower Back (Below L3)
Transmit RF Coil: Body
Receive Coil: Body or Extremity

2.2.4 Unsafe MR Conditions

i Note: For instructions specific to scanning patients with abandoned leads where use of the body coil for transmission of RF may be permissible, see “Special Cases and Considerations”.

Patients may be safely scanned with MRI only under the conditions given herein. The safety of scanning using other conditions has not been evaluated and may result in severe patient injury. *In vitro* MRI-related heating tests with the transmit RF body coil have shown potentially injurious temperature increases in some cases. In particular, take care to ensure that scans *are not* performed on patients with VNS under the following conditions:

Group B Devices:

Magnetic resonance imaging (MRI) should not be performed with a magnetic resonance body coil in the transmit mode.

Group A and B Devices:

- Under no circumstances should the transmit RF coil be placed over the VNS System. Because of this restriction, scanning of the area where the VNS System is implanted is not possible. See Figure 3 for details.

- Open MRI scanners should not be used for scanning VNS patients.

i Note: Testing was only performed using closed (i.e., cylindrical) MRI scanners.

- Systems other than 1.5 T and 3 T should not be used for scanning VNS patients.

2.2.5 Unsafe MR Imaging Scenarios

Under no circumstances should the transmit/receive head or extremity coil be placed over the shaded exclusion zone defined in Figure 3-1 or the iso-center of the scan (center of the MRI bore) be inside the shaded exclusion zone in Figure 3-2.

⚠ Caution: This exclusion zone is dependent upon the typical placement of the VNS Therapy System and placement of the extremity coil or positioning of the iso-center cannot be inside the exclusion zone under any circumstances.

⚠ Caution: Surgical removal of the VNS Therapy System *will be required* if an MRI of the exclusion zone is needed. See the *Revision / Replacement / Removal* chapter for instructions.

Figure 3. Unsafe MR - Exclusion Zone

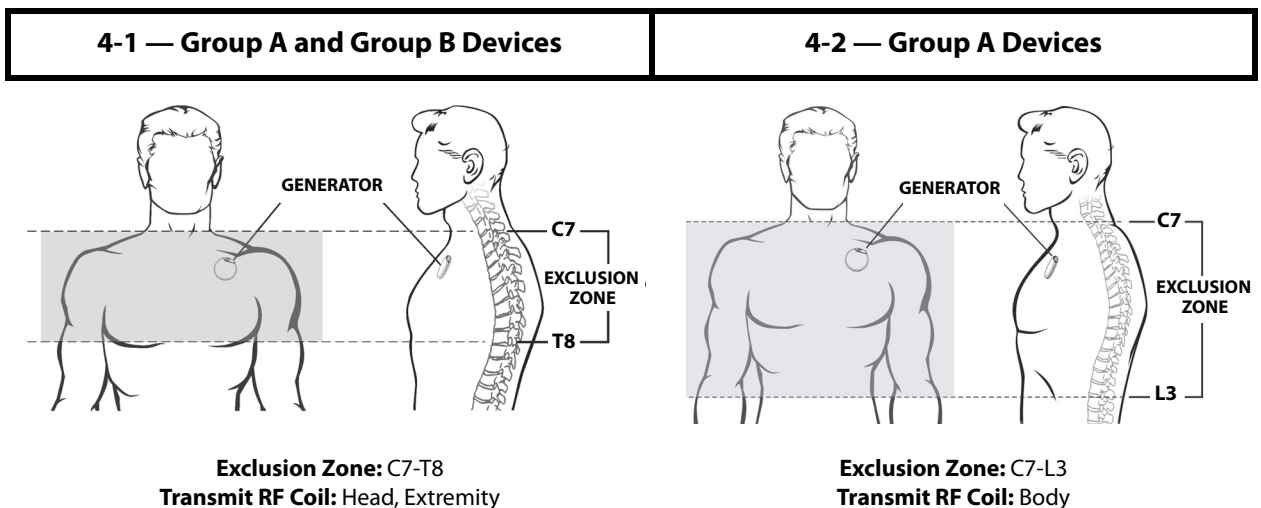

The VNS Therapy System, usually located between C7 and T8, must not be exposed to any RF field from a transmit RF coil. Figure 4 shows examples of unsafe MR imaging.

Figure 4. Unsafe MR Imaging

5-1 — Group A Devices

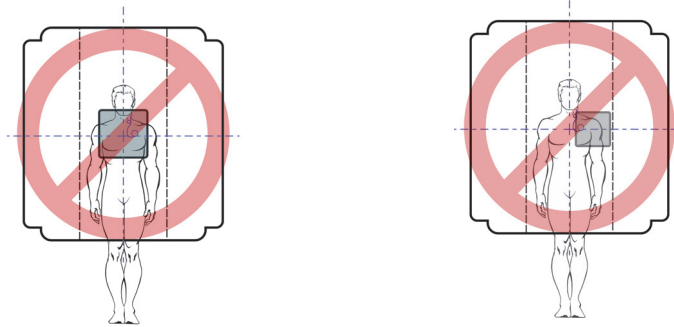

Area of Interest: Iso-center inside C7-L3
Transmit RF Coil: Body

Area of Interest: Iso-center inside C7-T8
Transmit RF Coil: Extremity

5-2 — Group B Devices

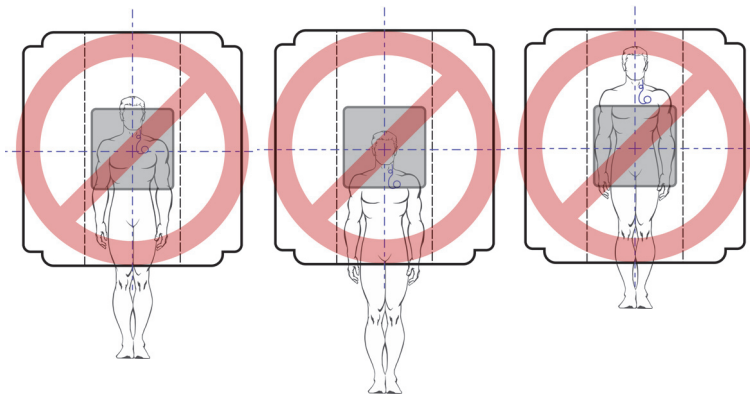

Area of Interest: Any
Transmit RF Coil: Body







i Note: The crosshairs indicate the iso-center of the MR system's bore.

2.2.6 Special Cases and Considerations

2.2.6.1 *Partially explanted VNS Therapy Systems or damaged leads*

The primary risk of MRI to VNS patients is MRI-related heating of the lead. Testing and computer modeling have shown; however, that MRI can be performed safely under the conditions and configurations listed in Table 3.

Table 3. Scan Conditions for Partially Explanted VNS Therapy Systems or Damaged Leads

Implant Configuration	Scan Conditions	
	1.5T or 3T with transmit/receive Head Coil or transmit/receive Extremity Coil	1.5T or 3T with transmission of RF with the Body Coil
VNS Therapy System with a suspected lead break (IPG is still connected)	 C7-T8 exclusion zone (i.e., Group B Scan Conditions)	
Lead length > 2 cm remains (No IPG)	 C7-T8 exclusion zone (i.e., Group B Scan Conditions)	
≤ 2 cm of lead remains (i.e. electrodes remain implanted and no IPG)	 no exclusion zones	 any landmark, no exclusion zones

 **Note:** See “MRI Conditions for Use” for further guidelines.

2.2.6.2 Assessing Lead Segment Length

If an MR image is needed and must be obtained using the body coil, a safe length of lead segment remaining (i.e., ≤ 2 cm) implanted can be assessed by taking an x-ray. The length of 2 cm can be approximated by visualizing the distance between the positive and negative electrode (~1 cm). By design, there is approximately 1 cm between the positive electrode and the anchor tether, which is also likely remaining. Surgeons are instructed to remove as much of the lead as possible if explanting a system.

Figure 5 illustrates the relationship of the electrodes to each other and the positive electrode to the anchor tether. An MRI using the Body coil for transmission of RF, or MRI of the head or extremities with a Head coil or Local (Extremity) coil (respectively) for transmission of RF is allowed if the lead is transected as seen in Figure 5.

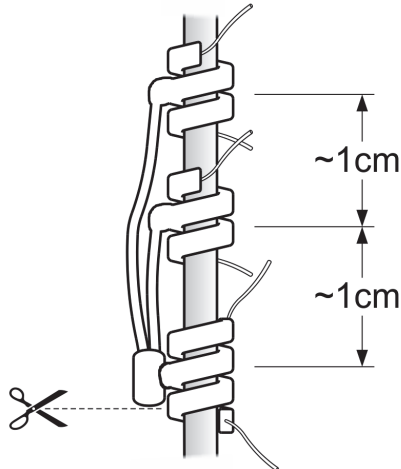
Figure 5. Transected Lead (≤ 2 cm)

If the lead is transected as seen in Figure 6, only a transmit/receive head MRI or transmit/receive extremity MRI is recommended. A full body MRI is not allowed.

Warning: If it appears that more than 2 cm of lead remains, then the patient cannot have an MRI with the body coil, but can still have an MRI using a extremity transmit/receive or head transmit/receive coil as instructed in this chapter. Abandoned lead wires present increased risk of thermal injury to patients during MRI procedures based on their length and their exposure to RF.

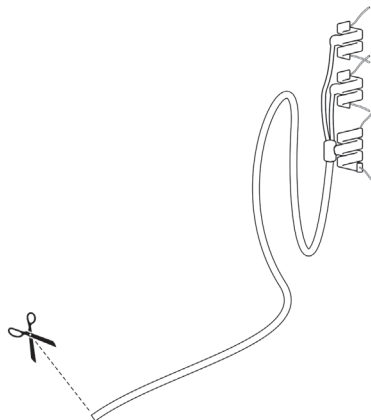
Figure 6. Transected Lead (> 2 cm)

2.2.7

MR Unsafe Devices

The VNS Therapy programming system, including the programming wand and the programming computer are MR Unsafe. The patient magnet is also MR Unsafe. These devices must not be brought into the MR scanner room.

Many VNS patients or caregivers carry magnets to activate and inhibit the VNS Therapy System. A small magnet, which can attach to a wristband or belt clip, is included in the kit given to all VNS patients. The magnet may be accidentally carried into an MR scan room, where it could cause damage or injury if it becomes a projectile. Screen all VNS Therapy patients to make sure they do not carry their patient magnet into the MRI scan room.

Figure 7. MR Unsafe Devices

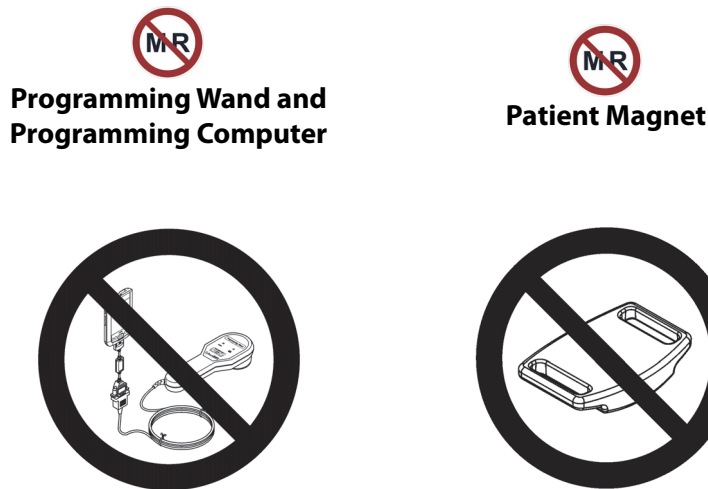

2.3 Post-MRI Assessment

After the MRI procedure, an appropriate healthcare professional with access to a VNS Therapy programming system must assess the condition of the VNS Therapy System.

To assess the VNS Therapy System:

1. Interrogate the VNS device.
2. If the generator was reset during the scan, reprogram the serial number, patient ID, and implant date, as needed.

 **Note:** For a complete list of information needed to restore the device settings (Model 102R and earlier devices), see “Pre-MRI Considerations and Preparation”.

3. Program the patient’s therapeutic parameters as they were *before the MRI procedure*.
4. Perform System Diagnostics. Results should indicate **Impedance = OK**.
5. Interrogate the device again to confirm that reprogramming was successful.

3 POTENTIAL RISKS AND EFFECTS OF MRI WITH VNS

The potential risks of performing MRI on patients with an implanted VNS Therapy System include:

- Heating effects around the VNS Therapy System, especially electrodes, from RF energy
- Non-significant levels of current induced through the VNS lead wire by time-varying gradient and RF fields
- Inadvertent device reset (Model 8103, Model 104 and earlier devices)
- Inadvertent *Magnet Mode* stimulation from magnetic fields if Magnet Mode was left on (epilepsy patients only)

- Delivery of AutoStim may occur if the feature is programmed on and a rapid increase in heart rate occurs (Model 106 and 1000 only)
- Vibration or movement of the device or lead
- Image artifacts and distortion
- Device malfunction or damage



Note: For complete VNS indications, contraindications, warnings, and precautions, see the *Introduction to the VNS Therapy System* chapter.

3.1 MRI-related Heating Effects

If the specific MRI conditions are not followed, tissue damage may result from excessive temperature increases at the electrode end of the lead during MRI scans. Damage to the vagus nerve and/or surrounding structures in the carotid sheath is of particular concern due to the location of VNS Therapy System stimulation electrodes.

The degree of MRI-related heating observed is primarily influenced by location of the patient in the MR system and by lead wire configuration and length.

Group A Devices:

Safe levels of heating, typically less than a 2 °C increase, were shown during numerical simulations for acceptable imaging scenarios (see “Conditional MR Environments for VNS”). In some cases the heating was found to be higher than 2 °C, but these results have also been demonstrated to be safe.

Group B Devices:

 **Caution:** Surgical removal of the VNS Therapy System *will be required* if MRI using a transmit RF body coil is needed. See the *Revision / Replacement / Removal* chapter for instructions.

For some Group B device configurations, *in vitro* tests have shown clinically significant heating of the VNS Therapy System stimulation electrodes of up to a 30 °C increase and higher during MRI scans of the head and/or body when the transmit RF body coil was used to apply RF energy. However, safe levels of heating, consistently less than a 2 °C increase, were shown during *in vitro* tests and numerical simulations for the acceptable imaging scenarios (see “Conditional MR Environments for VNS”).

3.2 Gradient Induced Current

There is no safety risk to the patient from MRI gradient induced currents through the device’s lead wire. By design, the VNS System delivers levels of current within a specified range on a scheduled duty cycle throughout the day.

The currents induced by the MRI were measured, modeled, and demonstrated to be less than the lowest output required for nerve activation¹. Any current induced in the lead by MRI time-varying magnetic fields may result in slight tingling sensation.

¹ Smith CD, Geddes LA, Bourland JD. et al. *Cardiovascular Engineering* (2001) 1: 77.

3.3 Device Reset (Model 8103, Model 104 and Earlier Devices)

There is no safety risk to the patient from a device reset. For Model 102R and earlier devices some information (including serial number, implant date, stimulation parameters, and device operating time) may be lost from the VNS Therapy System generator during a device reset. Most erased data can be reprogrammed, but device operating time cannot.

Strong magnetic field gradients and RF energy, similar to that used to reset the generator by design, are present in the MR environment. Generator reset has not been observed during *in vitro* tests. A few cases of generator reset have been reported by VNS patients in association with MRI procedures. Clinically, nothing can be done to prevent this rare occurrence. In the event of a device reset and loss of data, the VNS Therapy programming system should be used to reprogram the device serial number, implant date, and stimulation parameters to their *pre-MRI scan values*.

i **Note:** For details on proper procedures to ensure data is not lost due to device reset, see “Pre-MRI Considerations and Preparation”.

3.4 VNS Magnet Mode Activation

i **Note:** Magnet Mode is only intended for use in Epilepsy patients.

Failure to program the Magnet Mode output to 0 mA may cause Magnet Mode activation by the MRI magnets leading to undesired stimulation.

Magnet Mode activation is a frequent occurrence near MR systems. For this reason, the VNS Therapy System Normal Mode and Magnet Mode and AutoStim Mode (Model 106 and 1000) output currents should be programmed to 0 mA *before patient entry into the MR system room*. Any other optional device features should also be disabled before patient entry into the MR system room.

3.5 VNS AutoStim Mode - Model 106 and 1000 Only

i **Note:** AutoStim Mode is only intended for use in Epilepsy patients.

If heartbeat detection remains “ON” during the MRI, the MRI may contribute to false detections. If the AutoStim Mode output has not been programmed to 0 mA, the VNS Therapy System AutoStim Mode may be activated during the imaging, which may result in undesired stimulation.

Specific testing of this mode in the MRI environment has not been performed. However, if detection is turned off prior to MRI (See “Pre-MRI Considerations and Preparation”), the device is expected to behave in the same way as VNS generators without the AutoStim feature. The VNS Therapy System Normal Mode, AutoStim, and Magnet Mode output currents should be programmed to 0 mA, and detection should be programmed “OFF” prior to patient entry into the MR system room.

3.6 Vibration or Movement

Patients may feel a tugging or vibrating sensation at the site of the generator. The VNS Therapy System may experience magnetic field interactions associated with the static and gradient magnetic field of the MR system due to small amounts of material in the generator sensitive to magnetic fields. This may cause the generator to shift or vibrate slightly within the implant pocket and/or may place mechanical stress on tissues and/or the lead. The VNS Therapy System lead does not directly experience magnetic field interactions, since it is made from nonferromagnetic materials.

 **Caution:** Lower MRI static magnetic field strength does not imply greater safety. Only follow approved instructions in “Conditional MR Environments for VNS”

3.7 Image Artifacts and Distortions

Image artifacts or distortions may be observed under certain conditions. See Table 4 for details.

Table 4. Image Artifacts and Distortions

Type of Coil Used	Image Artifacts/Distortions
Head coil	None
Body coil	In non-clinical testing, the worst-case image artifact caused by the device extends approximately 100 mm from the generator when imaged with a gradient echo pulse sequence and a 3 T MRI system

3.8 Device Malfunction or Damage

Tests in various MR systems have not shown damage to, or malfunction of, any VNS Therapy System. If device malfunction or damage were to occur, it could cause painful stimulation or direct current stimulation. Either event may cause nerve damage and other associated problems (See “Adverse Events” in the indication-specific information chapters). If patients suspect a malfunction, they should be instructed to exit the MR system room and hold their magnet over their device to stop stimulation, and then contact their physician immediately for further evaluation. Prompt surgical intervention may be required if a malfunction occurs.

US



LivaNova USA, Inc.

100 Cyberonics Boulevard
Houston, Texas 77058
USA

Telephone

+1.281.228.7200
1.800.332.1375 (US/Canada)

Fax

+1.281.218.9332

24-HOUR SUPPORT

Telephone

1.866.882.8804 (US/Canada)
+1.281.228.7330 (Worldwide)

OUS



LivaNova Belgium NV

Ikaroslaan 83
B-1930 ZAVENTEM
BELGIUM

Telephone

+32.2.720.95.93

Fax

+32.2.720.60.53

24-HOUR SUPPORT

Telephone

+1.281.228.7330 (Worldwide)

INTERNET

www.livanova.com

© Copyright 2019 LivaNova, PLC, London, United Kingdom
All rights reserved.

LivaNova is a registered United States trademark of LivaNova, PLC. NCP, Demipulse, Demipulse Duo, Perennia, VNS Therapy, AspireHC, PerenniaFLEX, PerenniaDURA, AspireSR and SenTiva are registered United States trademarks of LivaNova USA, Inc. Pulse, Pulse Duo and Symmetry are trademarks of LivaNova USA, Inc. Corresponding foreign trademarks may also be registered or pending.